

# Study of the effect of silver in the mechanical properties and electrical conductivity of duralumins (Al-4%Cu-0.5%Mg)

Reinaldo Correa-Avendaño <sup>a</sup>, Héctor Darío Sánchez-Londoño <sup>b</sup> & Edwin García-Quintero <sup>c</sup>

<sup>a</sup> Department of Mechanical Engineering, Faculty of Engineering, University of Antioquia reinaldo2560@yahoo.es

<sup>b</sup> Department of Materials Engineering, University of Antioquia, hsanchez@udea.edu.co

<sup>c</sup> Department of Electrical Engineering, University of Antioquia, egarciaq@udea.edu.co

Received: September 5th, de 2013. Received in revised form: April 10th, 2014. Accepted: May 28th, 2014

## Abstract

This study evaluated the effect of the silver content of Al-Cu based alloys on the microstructure, the tensile strength, the electrical resistance and the temperature increase with the passage of electric current (Joule effect). For that purpose, Al-4% Cu-0, 5% Mg alloys were tested with silver content in proportions of 1.5%, 2.5% and 3.5%. Precipitation hardening was carried out by homogenization heat treatment of solid solutions. The microstructure analysis was carried out using optical microscope and SEM, Vickers hardness tests was also performed, tests of tensile strength and electrical conductivity, which were compared with the alloy A356-T6. The results of this research show that the increase of silver in the alloy increased tensile strength and decreases the resistivity. By SEM and EDS analysis of the phase  $\theta$  (CuAl<sub>2</sub>), Al<sub>6</sub> (Cu, Fe) and Al<sub>7</sub>Cu<sub>2</sub>Fe was observed.

*Keywords:* Duralumin, hardening by precipitation, homogenization, aging, phases, electrical resistance of metals, metals Joule effect.

# Estudio del efecto de la plata en las propiedades mecánicas y conductividad eléctrica de los duraluminios (Al-4%Cu-0,5%Mg)

## Resumen

En este trabajo se evalúa el efecto del contenido de plata de las aleaciones base Al-Cu en la microestructura, la resistencia a la tracción, la resistencia eléctrica y el incremento de la temperatura con el paso de la corriente eléctrica (efecto Joule). Para tal fin, fueron evaluadas las aleaciones Al-4%Cu-0,5%Mg con contenidos de plata en proporciones del 1,5%, 2,5% y 3,5%. El endurecimiento por precipitación se llevó a cabo mediante tratamientos térmicos de homogenización por solución sólida. El análisis de la microestructura se realizó mediante el microscopio óptico y SEM, además, se realizó análisis de dureza Vickers, ensayos de resistencia a la tracción y pruebas de conductividad eléctrica, las cual se compararon con la aleación A356-T6. Los resultados de esta investigación muestran que el aumento de la plata en la aleación aumenta la resistencia la tracción y disminuye su resistividad. Mediante el análisis del SEM y EDS se observó la fase  $\theta$  (CuAl<sub>2</sub>), Al<sub>6</sub>(Cu, Fe) y Al<sub>7</sub>Cu<sub>2</sub>Fe.

*Palabras clave:* Duraluminios, endurecimiento por precipitación, homogenización, envejecimiento, fases, resistencia eléctrica de metales, efecto Joule en metales.

## 1. Introduction

The process of new materials to be changed into good quality finished products is in continuous development and progress. For example, in the field of engineering materials high temperature resistant materials are sought along with other features such as corrosion resistant, low weight, low cost, easy shaping, abundant in nature, that can be recycled, long lifetime, good conductive properties, low heat production when there is passage of electric current, among others.[1]

For these reasons, this paper develops an aluminum base

alloy, designated ANSI 201, with additions of silver above the percentages that the standards present, capable of satisfying the above properties and the demands that are required of a structural material such as high mechanical resistance and often good electrical conductivity. In this sense, these alloys are reported to be the most resistant within the families of aluminum based alloys, which makes them very special and appreciated in the aerospace, automotive industry, hydroelectric power stations and in the transmission and distribution electric systems. These last ones were used as hardware [2,3].

## 2. Background

### 2.1. Duralumin Processes

In the alloys Al-4% Cu-0.5% Mg hardening elements such as copper, magnesium and silver, considerably increase their resistance to a T6 heat treatment, which is a homogenization treatment in a solid solution at a temperature between 520°C - 550°C and then quenched in water at a temperature of 18°C and artificially aged at a temperature of 150°C - 200°C for different times (in hours) [3,4].

The corrosion resistance becomes important for those elements or components that operate in very aggressive media, such as the case of internal combustion engines and turbines, and others [5,6].

The addition of silver-based alloys Al-Cu-Mg to modify the decomposition kinetics of the formation of phases and delay the degradation of the material at high temperatures [7,8]. This behavior is attributed to the formation of a fine and uniform dispersion of precipitates in a known phase  $\Omega$ , which presents hexagonal forms on the planes of the aluminum matrix  $\{111\}$   $\alpha$ .  $\Omega$  phase is thermodynamically more stable than the incoherent phase and equilibrium phase  $\theta$  in the Al-Cu system [9,10].

### 2.2. Electrical conductivity of the alloys

The incorporation of silver in the alloy improves the electrical conductivity due to two reasons, on one hand silver is a better conductor than the other components of the duralumin and, secondly, it has been dispersed in the matrix or in the alloy phases during the internal change in the structure that occurs due to the homogenization heat treatment and the isothermal aging of the alloy [11]. Additionally it is observed that alloys of silver improve the conductivity of duralumin over traditional alloys and are commonly used in high-voltage lines tensioners A356 - T6. [12].

## 3. Procedure

### 3.1. Obtaining the alloys

The alloys casting was performed with chemically pure elements, at least 99.9% purity, and a conventional temperature of 750°C in a laboratory casting. For the study 3 alloys were manufactured, with 1.5%, 2.5% and 3.5% of Ag. After obtaining the samples, the chemical composition was analyzed by spectrometry, yielding the following data:

Table 1.  
Chemical composition of the alloys made with 1.5%, 2.5% and 3.5% Ag

Alloys Al-4%Cu-0,5%Mg	1,5% Ag	2,5% Ag	3,5% Ag
Al	94,030	94,140	94,54
Si	0,307	0,061	0,311
Fe	0,155	0,141	0,256
Cu	4,855	4,985	4,151
Mg	0,627	0,634	0,64
Ag	1,5	2,5	3,5

mm were prepared for each of them and then homogenized in muffle furnace at 520°C, placed for 40 hours in warm water at room temperature and then aged at different times (0 h, 0.5 h, 1.0 h, 1.5 h, 2.0 h, 2.5 h, 3.0 h, 3.5 h, 4.0 h, 4.5 h, 5.0 h 5.5 h) and temperatures of 180°C, 200°C and 220°C, to obtain the Vickers hardness and tensile strength for each aging time. Subsequently the samples were metallographically prepared by gradual grinding with sandpaper and polished with plush to a mirror finish.

To make the Vickers hardness measurements a microhardness tester with a load of 100 gf, and diamond indenter was used. Then the samples were attacked with Keller reagent for observation in the scanning electron microscope (SEM).

### 3.2. Electrical measurements

Measurements of the electrical conductivity were performed with a Model 4200-SCS Semiconductor Characterization System, which gives a high measurement sensitivity and high accuracy. For this, the four specimens were made with the same geometry and dimensions.

Moreover, the measurement of temperature with respect to current flow was conducted with a thermographic camera, which uses the principle of infrared rays to detect heat. Current was supplied by a three phase power transformer with the secondary short circuited through the test object in order to obtain large currents (10 A to 100 A) passing through the object.

## 4. Results and analysis

### 4.1. Analysis of the microstructure by scanning electron microscope (SEM-EDS)

The image of Fig. 1 shows the SEM micrograph of the alloys Al-4% Cu-0.5% Mg 3.5% Ag as cast. It clearly shows a structure consisting of grains, an  $\alpha$  phase in the center of the grain and a  $\theta$  phase in grain boundary, forming the structure by slow cooling, according to the phase diagram of Al-Cu. In this state the material is soft and has very poor mechanical properties.

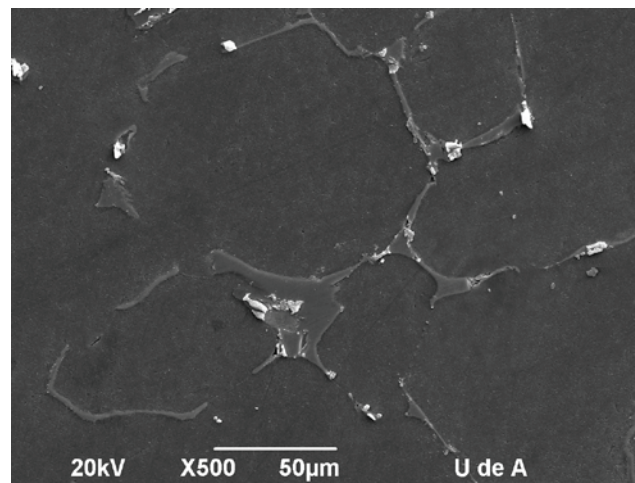

Figure 1. Micrograph of the alloy Al-4% Cu-0.5% Mg, as cast, with 3.5% Ag.



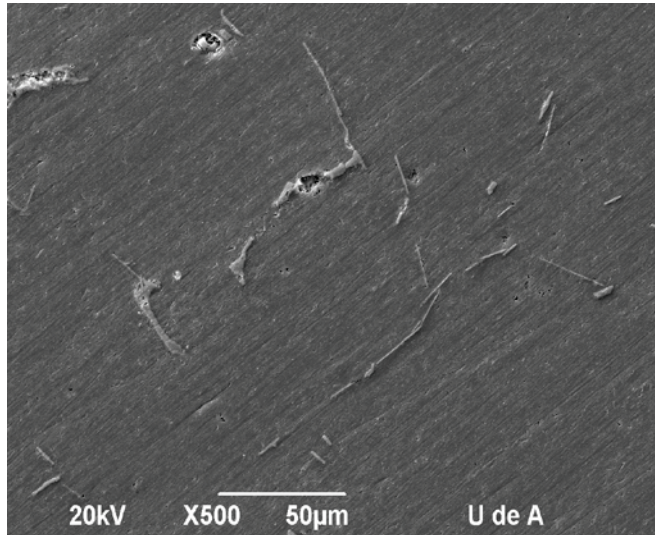

Figure 2. Micrograph of the alloys Al-4% Cu-0.5% Mg-3.5% Ag with heat treatment.

Fig. 2 shows the SEM micrograph of the alloy Al-4% Cu-0.5% Mg-3.5% Ag with homogenized heat treatment at 520°C for 40 hours, water-quenched at room temperature and then aged at 180°C for 4 hours. The footage clearly shows a structure consisting of chunks scattered grain boundaries and precipitates in the matrix, this as a result of the homogenization heat treatment and aging, in which  $\theta$  dissolves in  $\alpha$ , according to the phase diagram of Al-Cu, giving thus a hard matrix and a material with good mechanical properties, resulting in a duralumin.

Fig. 3 shows the SEM micrographs of the Al-4% Cu-0.5% Mg 3.5% Ag which clearly shows the phases (precipitates) formed therein after the heat treatment, which are extended for better observation and arrowed. The image 3 (a) corresponds to a phase precipitated  $\theta$  ( $\text{CuAl}_2$ ) and Fig. 3 (b) shows several precipitates dispersed in the matrix in different ways. In others, there is a strip-shaped pellet, compound of  $\text{Al}_6(\text{Cu, Fe})$ .

Finally, Fig. 4 shows that the EDS analysis was performed on the inside and outside of the pellet, with their respective spectra, which confirms the above, the grain boundaries are composed primarily of aluminum and copper (interior of the precipitate) as shown by the peaks of the spectrum. Silver and magnesium dissolved in the matrix (out of the precipitate). Phase  $\theta$  is also confirmed ( $\text{CuAl}_2$ ) as shown in the image(a) inside the other precipitates or precipitated phases as  $\text{Al}_6(\text{Cu, Fe})$  and  $\text{Al}_7\text{Cu}_2\text{Fe}$ ; phases reported in the literature in the form of blades or knives eutectically elongated when forming [13]. It is clear that trace elements found such as Fe and Ni, do not correspond to the alloy and these are the result of contamination of the utensils used in aluminum smelting. The precipitates in the form of leaves, blades and elongated strips may be presented as the product of the iron, which is not beneficial to the alloy since these tend to be fragile, with tendencies to crack formation, introducing concentrations of effort that lower the tensile strength in the material and significantly affect the ductility.

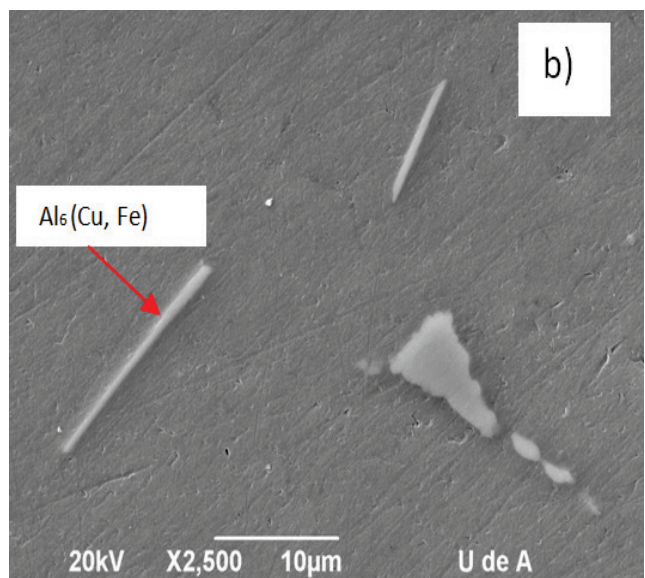
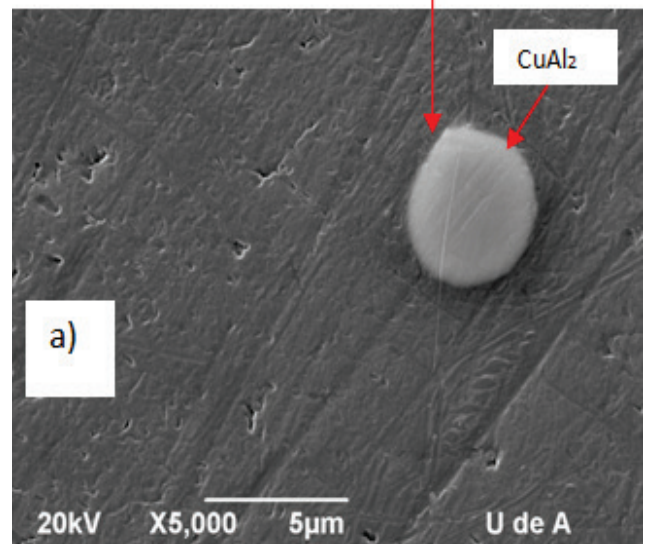
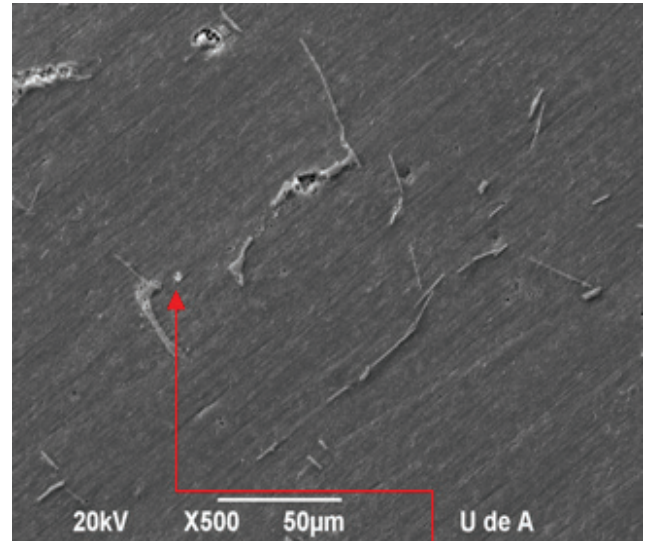

Figure 3. Micrographs of the phases formed in the alloys Al-4% Cu-0.5% Mg-3.5% Ag, with heat treatment.

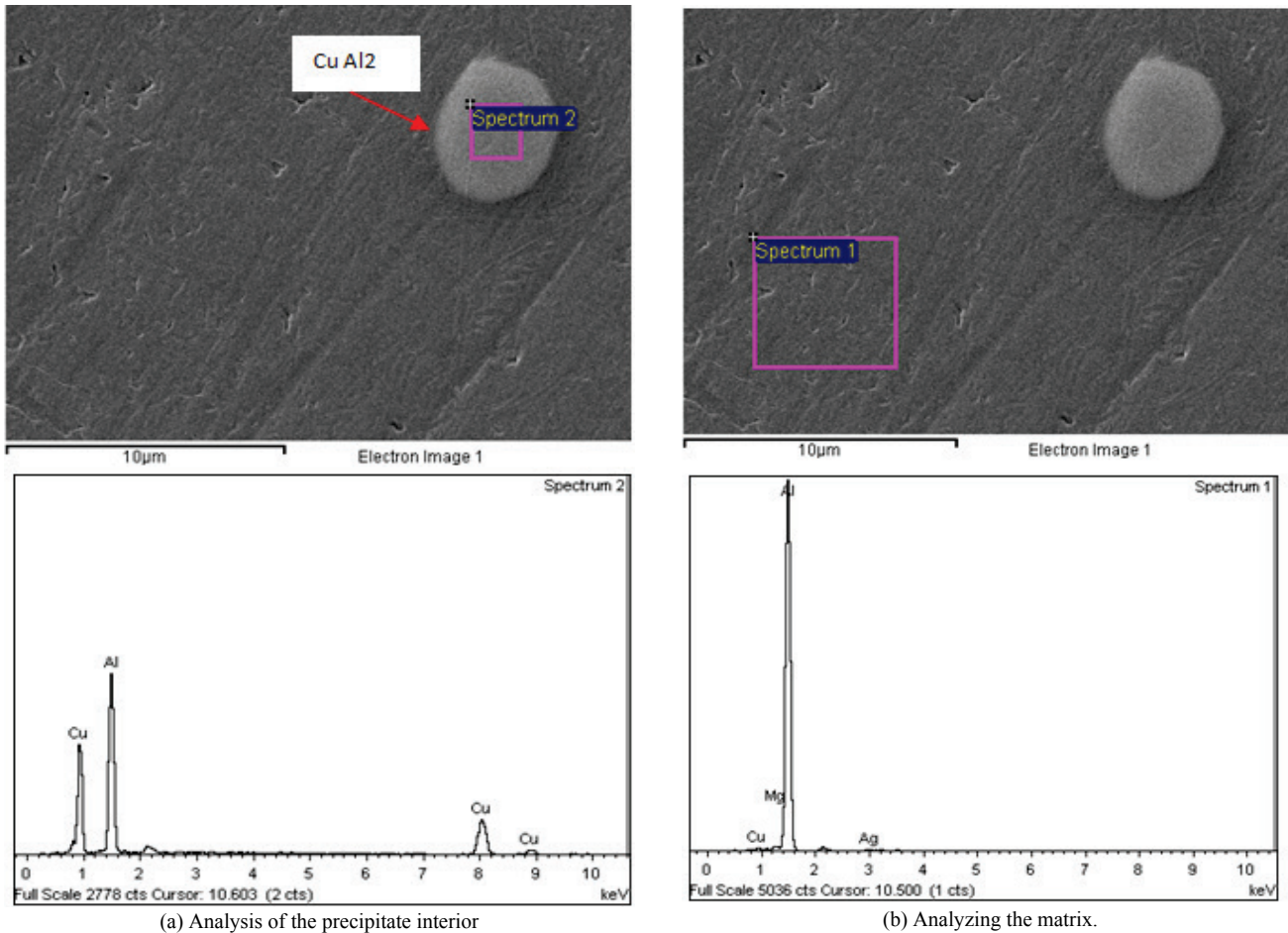

Figure 4. Micrograph and spectrum analysis for the Al-4% Cu-0.5% Mg-3.5% Ag, heat treated.

#### 4.2. Results and analysis of hardness and tensile strength

The results obtained using the Vickers hardness test and tensile strength for the samples of the alloys with 1.5%, 2.5% and 3.5% of Ag, homogenized at 520°C for 40 hours, cooled in water at a temperature of 18°C and aged at 180°C for different times, is observed in Figs. 5 and 6 respectively.

The Vickers hardness curves on Fig. 5 it shows the following behavior:

- In general, for a given aging time, the higher the concentration of silver in the alloy the higher the hardness (HV). This is because the silver delays homogenization time and accelerates aging time, causing precipitation of Guinier Preston zones, and therefore increases hardness of the material. This is perhaps the most important result of this work.

- In addition, for different times of aging, samples with 3.5% of Ag achieve higher hardness averages (14% more than that of 1.5% of Ag) as the samples with 2.5% Ag (7% more than 1.5% Ag) Ag and 1.5% which means that a higher silver content in the alloy, the average tensile strength also increases.

- The curves of Fig. 5 show that initially the hardness amount increases to a maximum value. This is because the precipitates have dissolved in the matrix which makes the alloy need less aging time to reach the maximum value,

since these precipitates strengthen Preston Guinier areas, which are responsible for giving the highest toughness.

- It can also be observed that in curves after reaching its maximum strength at an aging time of 3 hours for all samples, they begin to decline, thus giving over-aged alloys. This is because Guinier-Preston zones are formed at the beginning of the aging.

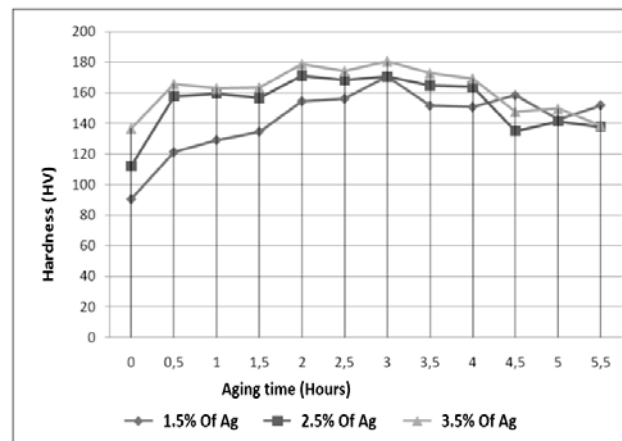

Figure 5. Vickers hardness curves vs. aging time for alloys Al-4% Cu-0.5% Mg 1.5%, 2.5% and 3.5% of Ag



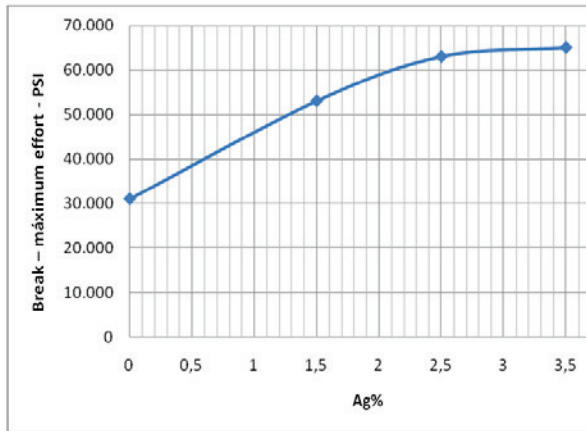

Figure 6. Curves of the maximum values of tensile strength of the alloys Al-4% Cu-0.5% Mg with 0%, 1.5%, 2.5% and 3.5% Ag

Table 2. Duralumin Electrical resistance at a room temperature of 22.8°C.

Silver content in Duralumin 201.2-T6	Cylinder diameter (mm)	Electrical resistance per unit length (mΩ/cm)
A356-T6 – Al to the 7% of Si	12,0	2,56
1,5% of Ag	11,8	2,68
2,5% of Ag	11,7	1,35
3,5% of Ag	12,0	0,36

Figs. 5 and 6 shows the curves of hardness and tensile strength, respectively, of the alloys Al-4% Cu-0.5% Mg 1.5%, 2.5% and 3.5% of Ag, where it is observed that the addition of silver promotes greater strength of the material at all aging temperatures. This phenomenon has been reported in the literature, where the strength of the material is maintained with increasing aging temperature, highlighting that the excessive increase of the temperature decreases the peak aged hardness and maximum [14], which confirms the results obtained in this work, which shows that increasing concentrations of silver, the resistance increases in all alloys, given that the silver stimulates the precipitation of hardening phases. As can be seen in the curve of Fig. 6, an increase of Ag in the alloys Al-4% Cu-0.5% Mg significantly increases the tensile strength; the higher silver content (3.5% Ag) reaches the highest value close to 65.000 psi, with respect to the content of 1.5% Ag with 2.5% Ag, 51.000 Psi and 62.000 Psi.

### 4.3. Results and analysis of electrical conductivity

After adding silver in these duralumins their electrical conductivity is affected as shown in Table 2.

Table 2 shows how increasing the proportion of silver in the alloy, the conductivity also increases (or the electrical resistance decreases). This is because, in addition to the reasons stated in section 2.2, the impurities of silver that are added to the material increase the number of conduction electrons that carry electrical current. In addition, the impurities (or silver) become part of the crystalline structure by substituting the corresponding aluminum atom. This method allows more electrons to transport electricity.

Therefore, the results show that alloys having an addition of silver improve the conductivity of the duralumin compared to the traditional and commonly used alloy A 356 - T6.[12]. However, there are exceptions in the case of the material with 1.5% of Ag, the electrical resistance is higher than Alloy A 356 - T6 (see Fig. 7). This is because silver forms a nanoprecipitate, however this is not evidenced in the metallographic (Figs. 1 to 3) due to the scale of the microscope, this nanoprecipitate affects the structure and improves the conductivity, but with percentages greater than 1.5% Ag [15]. This also has thermal effects, since electrical applications (such as hardware in electrical substations, electrical towers, electric poles, etc.) these materials may overheat the current flow due to the relatively high resistive values, generating hot spots or thermal fatigue of duralumin and electrical conductors in contact with it, or both. Fig. 7 illustrates this behavior.

The behavior depicted in Fig. 7 is primarily due to the influence of the resistance of each material on the temperature, which according to the results given in [11] is determined by the following expressions:

$$q'' = -k \nabla T \tag{1}$$

$$k \nabla^2 T + \dot{q} = \rho |\vec{J}|^2 \tag{2}$$

$$\dot{q} = \rho |\vec{J}|^2 \tag{3}$$

$$I = \int_S |J| dS \tag{4}$$

$$R = \rho \frac{L}{S} \tag{5}$$

$$\sigma = \frac{1}{\rho} \tag{6}$$

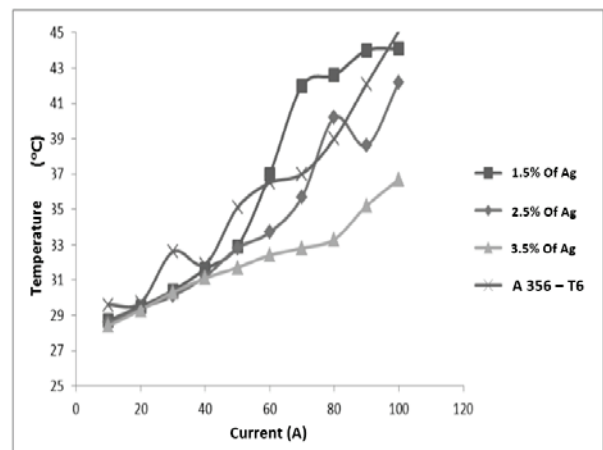

Figure 7. Current vs. temperature curves for the four samples of the alloys: 1.5% Ag, 2.5% Ag, 3.5% Ag and 356.

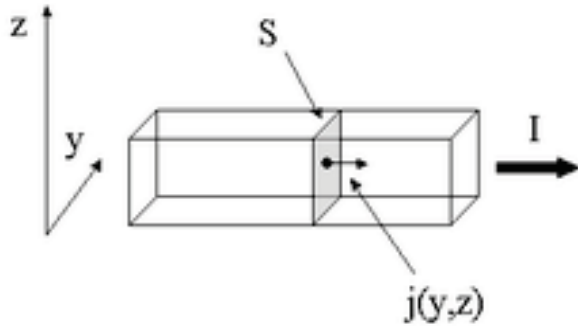

Figure 8. Metal volume cross section traversed by the current density  $j$  and the current density.

Where:  $q$  = heat flow  $k$  = thermal conductivity,  $T$  = temperature,  $q$  = heat generation Joule warming,  $\beta$  = mass density,  $CP$  = specific heat,  $t$  = time,  $\rho$  = electrical resistivity, conductivity =  $\sigma$  electrical,  $R$  = electrical resistance per unit length,  $L$  = conductor length,  $S$  = cross-sectional area of the conductor,  $I$  = electric current and  $J$  = electric current density. Fig. 8 shows some of these variables.

Equations (1)-(4) represent a nonlinear dependence between the temperature  $T$  and the electric current density  $J$  in metals. This dependency can be seen in the curves of Fig. 7 above, which shows that on average for a higher silver content in the alloy there is lower electrical resistance and, consequently, less temperature increase with the passage of current, plus the alloy A356-T6 has an average thermal behavior similar to the duralumins order with less silver content (1.5% Ag) and high electrical resistance.

Consequently, the rise in silver in duralumins alloys improves their electrical properties overcoming the A356-T6 alloy that has been widely used in industrial applications so far, it would be advantageous to use the duralumins with silver concentrations exceeding 1.5% in industrial electrical applications.

## 5. Conclusions

The alloys (Al-4% Cu-0.5 Mg with additions of Ag of 1.5% to 3.5%) require longer homogenization compared to conventional aluminum alloy base.

Hardness and tensile strength of aluminum-based alloys with additions of silver vary according to time and homogenization temperature, and aging time and temperature.

The increase in silver content between 1.5% and 3.5% in the alloy Al-4% Cu-0.5 Mg increases the tensile strength.

The high hardness and high mechanical properties of the alloy Al-4% Cu-0.5Mg with Ag, is due to the type of precipitates formed in the alloy in the heat treatment which are small and widely scattered.

The alloy with the highest percentage of silver content, presented better electrical conductivity and lower heating with electric current flow.

Clearly the changes in the properties of alloys in the system Al-4% Cu-0, 5% Mg with additions of silver under

conditions of suitable thermal treatments, through the formation of a fine dispersion of precipitated known phase  $\Omega$ , causing resistance in the material. And on the contrary there may be loss of strength in the material, due to thickening and loss of coherence  $\Omega$  precipitates after long time aging.

## References

- [1] Orozco-Henao, C., Mora-Flórez J. and Pérez-Londoño S., Iterative strategy to adjust the system load applied for locating in power distribution systems. DYNA 80 (177), pp. 59-68, 2013.
- [2] Teleshov, V. et al., Effect of chemical composition on the strength of the Al-Cu-Mg-Ag alloy system after heating at 180 – 210°C. Metal Science and Heat treatment 48(3-4), pp. 104-112, 2006.
- [3] Ber, L. B., Teleshov, V.V. and Ukolova, O. G., Aluminum and high – temperature alloys. Phase composition and mechanical properties of wrought aluminum alloys of the system Al-Cu- Mg-Ag-Xi. Metal Science and Treatment. Magazine 50 (5-6), pp. 220-227, 2008.
- [4] Aluminum casting technology. American Foundrymen's Society, Inc. D Plaines, 2th Edition, Illinois 1986, pp. 5-179.
- [5] Min, S. et al., Effect of Ce on the thermal stability of the  $\Omega$  phase in an Al-Cu-Mg-Ag alloy. Rare metals. 28 (2), pp. 156-159, 2009.
- [6] Xiao, D., Ding, J. and Chen, S., Effect of Cu content on the mechanical properties of an Al-Cu-Mg-Ag alloy. Journal of alloys and compounds 343 (1-2), pp. 77-78, 2002.
- [7] Ringer, P. et al., Precipitation stability in Al-Cu-Mg-Ag alloys aged at high temperatures. Acta Metalurgical et Materialia 42 (5), pp. 1715-1725, 1994.
- [8] Ber, L. et al., Aluminum and high – temperature alloys phase composition and mechanical properties of wrought aluminum alloys of the sistem Al-Cu-Mg-Ag-Xi. Metal Science and Treatment, Magazine 50 (5-6), pp 220-227, 2008.
- [9] Chang, Y. and Howe, J., Composition and stability of  $\Omega$  phase in Al-Cu-Mg-Ag alloy. Metallurgical Transactions A. 24A (7), pp. 1461-1470, 1993.
- [10] Ber, B. et. al., Phase composition and mechanical properties of wrought aluminum alloys of the system Al-Cu-Mg-Ag-Xi. Metal Science and Heat Treatment 50 (5), pp. 220-227, 2008.
- [11] Jin, T. and Liu, C., Effects of temperature-dependent material properties on stress and temperature in cracked metal plate under electric current load, World Academy of Science, Engineering and Technology 65, pp. 474-479, 2010.
- [12] Fernández, P. and Restrepo, O. J., Microestructural analysis of A356-T6 aluminum alloy on high tension connectors. Revista Facultad de Ingeniería Universidad de Antioquia 44, pp. 20-29, Junio 2008.
- [13] ASM metal handbook. Aluminum alloys: Metallographic techniques and microstructure, Vol. 9. USA. 1992. pp 707-804.
- [14] B. Zlaticanin, S. Duric, B. Jordovic and Radonjic. B., Communications Ltda. Published by maney for the Institute of Materials, Minerals and Mining. 2003, pp. 10-15.
- [15] Gu, G. Y., Liu, Z., Yu, D., Liu, B., Lin, M. and Zeng, S., Growth of X plates and its effect on mechanical properties in Al-Cu-Mg-Ag alloy with high content of silver. Journal of Materials Engineering and Performance 36, pp 1-8, 2013.

**R. Correa-Avenidaño**, He obtained a Bs. Eng. in Mechanical Engineering in 2001, a Sp. in Senior Management with emphasis on Quality in 2006 and MSc. in Engineering with emphasis on Metallic Materials in 2010 from the University of Antioquia. After working in a private company as a project

engineer and design through 2006, he is currently a professor at the Faculty of Engineering, Department of Mechanical Engineering, University of Antioquia.

**H. D Sanchez-Londoño**, He received a Bs. Eng. in Metallurgical Engineering in 1992, a Sp. degree in Quality Management in 1998 and a MSc in Materials in 2003, all from the University of Antioquia, Medellin, Colombia. From 1992 to 1995, he worked for foundries and from 1995 works at the University of Antioquia Colombia. He currently teaches at the Faculty of Engineering in the area of materials. His research interests include: castings, no phase transformations in alloys, railways, energy and statistical process control.

**E. García-Quintero**, He received a Bs. Eng. in Electrical Engineer in 2000 from the Industrial University of Santander (Colombia), an MSc degree in

Electrical Technology in 2006, and a PhD degree in Electrical Technology, Materials, Generation and Distribution in 2008, the latter two at the Technical University of Valencia (Spain). He is currently Professor in the Department of Electrical Engineering, University of Antioquia, and is director of the Research Group in the Materials and Energy Systems (TESLA) of the University of Antioquia. From 2000 to 2008, he worked on issues related to electrical systems (power quality, power systems and high voltage). After 2008 he worked on material used in the energy sector, mainly related to energy efficiency. In the last years he has been developing prototypes for use in the electricity sector and new materials used in efficient electrical transformers.